

2x1s Transcutaneous Spinal Direct Current (tsDCS) Stimulator

Model 0707-A

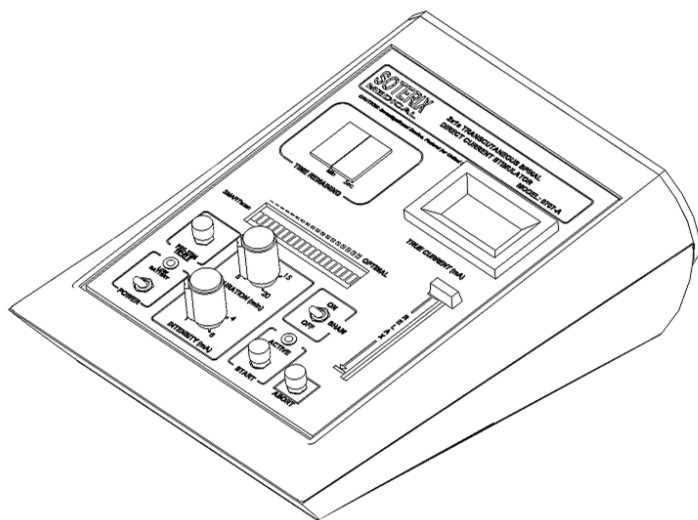

Operator's Manual

NOTICE

THE FOLLOWING MATERIAL IN THIS MANUAL IS EXCLUSIVELY FOR INFORMATIONAL PURPOSES. THE CONTENT AND THE PRODUCT IT DESCRIBES ARE SUBJECT TO CHANGE WITHOUT NOTICE. IN NO EVENT WILL **SOTERIX MEDICAL INC.**, BE LIABLE FOR THE DAMAGES ARISING FROM OR RELATED TO THE USE OF THIS MANUAL OR THE PRODUCT IT DESCRIBES.

Version 1
March 2011

CAUTION

As an ultimate user of this apparatus, you have the responsibility to understand its proper function and operational characteristics. This operator's manual should be thoroughly read and all operators given adequate training before attempting to place this unit in service.

Awareness of the stated cautions and warnings and compliance with recommended operating parameters – together with maintenance requirements – are important for safe and satisfactory operation. The unit should be used for its intended application. Recommended accessories should be used while using this system.

This page is left intentionally blank to provide an insertion place of any changes subsequent to the printing of this document.

Contents

Notice.....	ii
Caution.....	iii
Contents.....	v
Introduction	
Overview.....	2
Getting to Know the Product.....	3
Use of This Manual.....	4
Health and Safety	
Precautions and Warnings.....	6
Regulatory Statements.....	9
Product Description	
Items Supplied.....	11
Front Panel.....	12
Back Panel.....	13
Control Keys.....	14
Device Operation	
Inserting and Replacing the Batteries.....	16
Description of Special Features.....	18
Pre-Stimulation Setup.....	20
Diagrams.....	25
Stimulation Procedure.....	27
Specifications and Warranty	
Specifications.....	30
Electrical and Operating Characteristics.....	30
Storage and Operating Conditions.....	30
Warranty.....	31
Soterix Medical Limited Warranty	31
Obtaining Warranty Service.....	32
Further Information	
Bibliography.....	34
Contact Information.....	35

Introduction

Overview - 2
Getting to Know the Product - 3
Use of this Manual - 4

This chapter introduces you to the basics required to use this manual fully as well as operate the **Soterix Medical** 2x1s line of stimulators.

Overview:

This section gives a description of the process of Transcutaneous Spinal Direct Current Stimulation.

Getting to Know the Product:

Read this section to learn what sets the **Soterix Medical** 2x1s tsDCS Stimulator apart from the rest.

Use of this Manual:

Refer to this section for information on how this manual is organized as well as an explanation of the symbols used throughout the manual.

Overview

Transcutaneous Spinal Direct Current Stimulation (tsDCS) is a non-invasive procedure in which a device sends a small Direct Current (DC) across the skin to modulate spinal function. The **Soterix Medical 2x1s tsDCS Stimulator** sends a low-level current from the positive electrode(s), anode(s), to the negative electrode(s), cathode(s).

tsDCS mechanisms are considered to result from the ability of very weak DC currents to safely induce reversible changes in cellular plasticity. The induction of lasting changes in cellular excitability can, under some conditions, reversibly modify behavior and interact with normal learning.

tsDCS dose can be defined as: 1) The size and position of the electrodes on the body and 2) The duration (in minutes) and intensity (in mA) of current passed across the electrodes. **Soterix Medical** tsDCS systems allow precise reproduction of tsDCS doses commonly used in medical literature. **Soterix Medical** engineers can work with you to determine the best configuration for your application. tsDCS is an investigational technique and it is the responsibility of the operator to determine the appropriate tsDCS dose.

tsDCS safety is supported by medical literature to have common side effects limited to mild and reversible skin irritation, when using standard tsDCS protocols and guidelines. **Soterix Medical** tsDCS stimulators and electrodes are uniquely designed to minimize skin irritation – for example, the exclusive **SMARTscan™** feature provides a simple indicator to the operator of the contact conditions before, during, and after stimulation. tsDCS is an investigational technique and it is the responsibility of the operator to identify and follow the most appropriate safety protocols.

tsDCS comfort can be controlled by the operator by using devices, such as the **Soterix Medical 2x1s tsDCS Stimulator**, which are specifically designed for clinical tsDCS. For example, the unique **PRE-STIM TICKLE™** and **RELAX™** features available on all **Soterix Medical 2x1s** models are designed to condition the skin prior to stimulation and allow the operator to accommodate subject feedback without stopping stimulation.

tsDCS protocol, clinical results, and safety data can be better understood by consulting the papers found in the bibliography at the end of this manual.

Getting to Know the Product

Thank you for purchasing a **Soterix Medical 2x1s** Transcutaneous Spinal Direct Current Stimulator. Unlike other stimulators, the **Soterix Medical 2x1s** line is simple to use and designed especially for tsDCS.

The **Soterix Medical 2x1s** line of low-intensity tsDCS stimulators is designed to generate low levels of DC current between one or more anodes and one or more cathodes placed on the body. The anode is the positive electrode from which current from the device enters the body, while the cathode is the negative electrode from which current exits the body and returns to the device. The provided **Soterix Medical** tsDCS accessories allow for simple and comfortable positioning of the electrodes on the body. The operator must set the intensity of current (in units of mA) and duration of stimulation (in minutes) before initiating the stimulation. For both duration and intensity, there are four settings.

Clinicians and researchers choose the **Soterix Medical 2x1s** to:

- 1) Ensure reproducible and precise tsDCS operation across subjects and time.
- 2) Provide for simple and comfortable tsDCS set-up and stimulation.
- 3) Conduct clinical studies with state-of-the-art control and safety features.

The **Soterix Medical 2x1s** line includes several proprietary features to enhance tsDCS safety and subject comfort including TRUE CURRENT™, SMARTscan™, RELAX™, and PRE-STIM TICKLE™. By reading this manual and understanding these unique features, operators of the **Soterix Medical 2x1s** can enhance the efficacy and comfort of tsDCS.

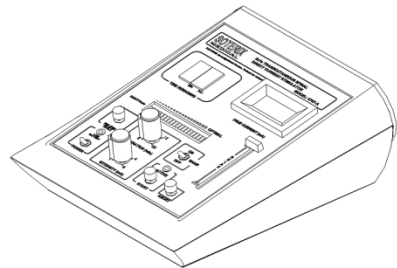

Use of This Manual

This manual contains details of installation, setup, and operation of the **Soterix Medical 2x1s** unit and its accessories. This manual must be read in its entirety before commencing any stimulation with the **Soterix Medical 2x1s** unit. If the instructions in this manual are not precisely followed, the performance of this product and/or the safety of the user and/or patient may be compromised. If you have any questions, comments, or concerns, please contact **Soterix Medical** before starting use of the device.

The consequences that could result from failure to observe the precautions listed in this section are indicated by the following symbol:



This icon marks warnings, information that should be read before using this **Soterix Medical** product to prevent possible injury.



Health and Safety

Precautions and
Warnings - 6

Regulatory
Statements - 9

This chapter dictates the required precautions for both your and your patient's safety.

Precautions and Warnings:

Read this section for the important list of precautionary measures required to operate this device.

Regulatory Statements:

This is where you will find the regulatory statements for certain countries, which determines how you may use this device under federal law.

Precautions and Warnings

To prevent damage to your **Soterix Medical** product or injury to yourself or to others, read the following safety precautions in their entirety before using this equipment. Keep these safety instructions where all those who use the product can easily access them.

- Environment and Moisture
 - Do not immerse the **Soterix Medical** 2x1s tsDCS Stimulator in water or any other fluids.
 - The **Soterix Medical** 2x1s tsDCS Stimulator should not be used in a moist environment or if any parts of the stimulator are damp or wet.
 - The **Soterix Medical** 2x1s tsDCS Stimulator is not certified for use in the presence of a flammable anesthetic mixture with air or oxygen or nitrous oxide. The consequences of using the **Soterix Medical** 2x1s tsDCS Stimulator near flammable atmosphere are unknown.
 - The **Soterix Medical** 2x1s tsDCS Stimulator is not certified for use in an environment with strong magnetic fields (including, but not limited to, MRI). The consequences of using the **Soterix Medical** 2x1s tsDCS Stimulator in a strong magnetic environment are unknown.
 - Do not use the **Soterix Medical** 2x1s tsDCS Stimulator if it was transported or stored at temperatures outside of the specific range indicated in this manual. Allow the equipment to stabilize to a temperature within the specific range before use.
- External Damage
 - Do not drop the device.
 - The **Soterix Medical** 2x1s tsDCS Stimulator should not be used if there are any signs of external damage.
 - Carefully inspect the device on arrival and prior to each use.
 - If any controls or displays are not working as indicated in this manual, do not use the **Soterix Medical** 2x1s tsDCS Stimulator. Immediately return the device to **Soterix Medical Inc.** for repair.

- Cables
 - When connecting cables to the output jacks, use only the cables provided or sold by **Soterix Medical Inc.** to maintain compliance with product regulations.
 - Make sure all cables are fully inserted in the correct receivers before operating the **Soterix Medical 2x1s tsDCS Stimulator**.
- Irritation
 - Use only approved **Soterix Medical Inc. EASYpads™** tsDCS kits indicated for use with the **Soterix Medical 2x1s tsDCS Stimulator**. Do not modify the EASYpads™ tsDCS kits. Do not reuse EASYpads™ tsDCS kits that are indicated only for single use.
 - The **Soterix Medical 2x1s tsDCS Stimulator** may cause minor irritation, discomfort, and redness at the electrode sites. If irritation occurs, consult your clinician.
 - Do not place tsDCS electrodes or sponges over previously irritated, burnt, or damaged skin.
- Internal Parts
 - Do not disassemble. Touching the product's internal parts could result in injury. In the event of a malfunction, only a qualified technician should repair the product from **Soterix Medical Inc.** Should the product break open as the result of a fall or other accident, remove the batteries and return the product to **Soterix Medical Inc.** for repairs.
- Batteries
 - Observe proper precautions when handling batteries. Be sure the product is OFF before replacing batteries.
 - Use only batteries approved for use in this equipment. Do not attempt to insert batteries upside down or backwards.
- Technique
 - The **Soterix Medical 2x1 tsDCS Stimulator** must only be used with appropriate supervision and by a trained operator. Even experienced operators must carefully read and fully follow all the following instructions and guidelines.

- All operators must ensure that tsDCS is applied within local and federal or country guidelines as relevant.
- The **Soterix Medical** 2x1s tsDCS Stimulator should not be used in combination with any other implanted or external electrical stimulation device.
- Disposal
 - Return the device to **Soterix Medical Inc.** for disposal when the device is no longer functional.

Regulatory Statements

Transcutaneous Spinal Direct Current Stimulation (tsDCS) is an investigational technique. It is limited by Federal law to investigational use under appropriate Institutional Review Board guidelines.

USA:

CAUTION: The Soterix Medical 2x1s Transcutaneous Spinal DC Stimulator is an investigational device. Federal (or United States) law limits device to investigational use.

Product Description

Items Supplied - 11

Front Panel - 12

Back Panel - 13

Control Keys - 14

This chapter is comprised of the following sections:

Items Supplied:

This section gives a checklist of the items that are found in every package sent out for the 2x1s tsDCS Stimulator as well as any items that could be sent out additionally to the standard package.

Front Panel:

This section contains an illustration of the front panel with every button labeled numerically.

Back Panel:

This section contains an illustration of the rear panel with every button labeled numerically.

Control Keys:

Here is a basic description of all the controls and display functions indicated in the previous two sections.

Items Supplied

- 1 **Soterix Medical** 2x1s tsDCS Stimulator
- 3 **Soterix Medical** rubber electrodes
- 2 Red anode cables
- 2 Black cathode cables

Items Supplied Separately

- Soterix Medical** 718 stimulation fluid (500 mL, 1 L)
- Soterix Medical** tsDCS Lumbar *BODYstrap™* (shown below)
- Soterix Medical** tsDCS Cervical *BODYstrap™*
- Replacement **Soterix Medical** *EASYpads™* tsDCS kits
 - Lumbar kit: 1 active (5x10cm) sponge and 2 return (7x7cm) sponges
 - Cervical kit: 1 active (5x7cm) sponge and 2 return (7x7cm) sponges



Front Panel

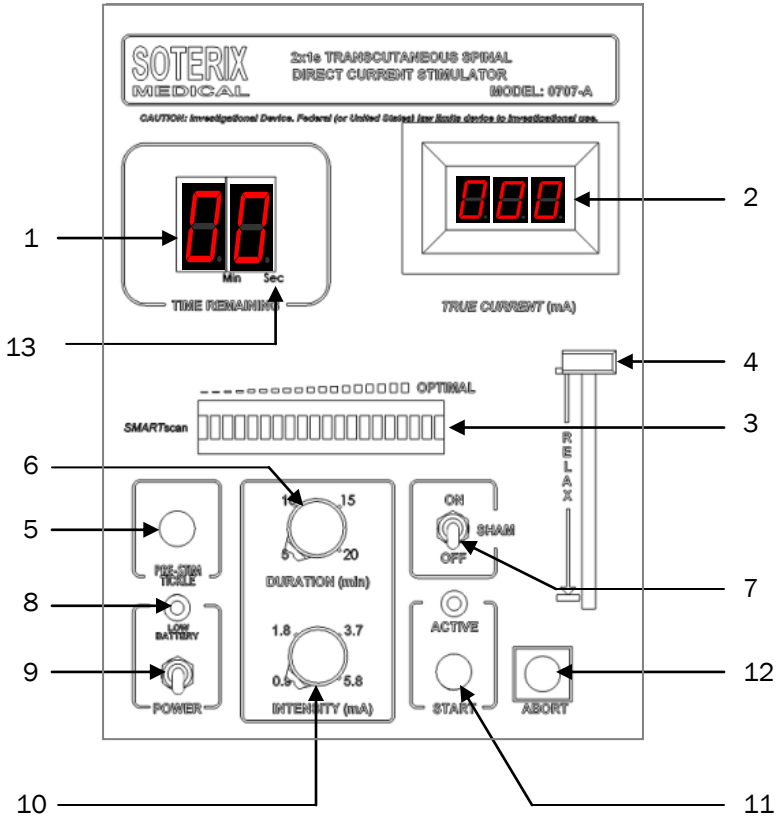

Back Panel

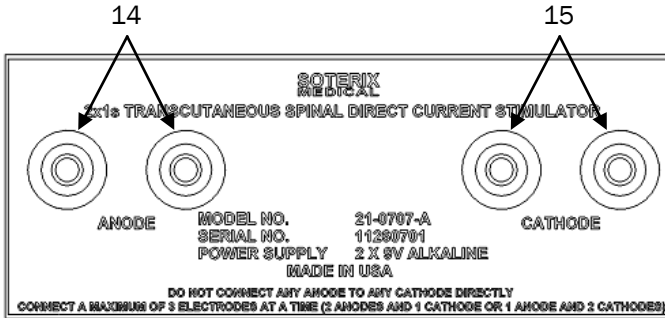

Control Keys

- 1: A display, which indicates the amount of time remaining in the stimulation. The display reads in minutes unless the seconds light (13) is illuminated.
- 2: A display that indicates the amount of current being produced by the device.
- 3: A display which indicates how “good” the contact quality of the leads are.
- 4: Modulates the current value being produced by the device.
- 5: Starts the PRE-STIM TICKLE™.
- 6: Adjusts the duration of the stimulation (5, 10, 15, or 20 minutes) prior to the start of stimulation.
- 7: Activates or deactivates SHAM.
- 8: Indicates if there is low battery by illuminating red.
- 9: Turns ON or OFF the device.
- 10: Adjusts the current (0.9, 1.8, 3.7, 5.8 mA) prior to the start of stimulation.
- 11: Starts the stimulation.
- 12: Stops the stimulation.
- 13: A light that, when illuminated, indicates the TIME REMAINING display (1) is representing seconds as opposed to minutes.
- 14: The connectors for the anode cables.
- 15: The connectors for the cathode cables.

Device Operation

Inserting and Replacing
the Batteries - 16

Description of Special
Features - 18

Pre-Stimulation
Setup - 20

Diagrams - 25

Stimulation
Procedure - 27

This chapter gives a systematic process for operating your **Soterix Medical 2x1s tsDCS Stimulator**

Inserting and Replacing the Batteries:

This section explains how you must insert the batteries into the device. It also explains how to replace them and when it is required.

Description of Special Features:

This section gives an in-depth description of all the special features that come with your purchase of this **Soterix Medical** device.

Pre-Stimulation Setup:

Here you will find the first things you must do to prepare the device and subject prior to stimulation

Stimulation Procedure:

Here is the procedure for the tsDCS. It gives a list of what the operator must do and that the device does during stimulation.

Inserting and Replacing the Batteries

The 2x1s tsDCS Stimulator operates on two 9V alkaline batteries. Duracell is recommended.

To insert the batteries, flip the device to its back and remove the battery cover. Correct battery polarity is indicated inside the battery cover (right). The positive connectors should be toward the outside edges of the device.

Then, insert the two batteries, one at a time, ensuring proper battery orientation for each battery (below).

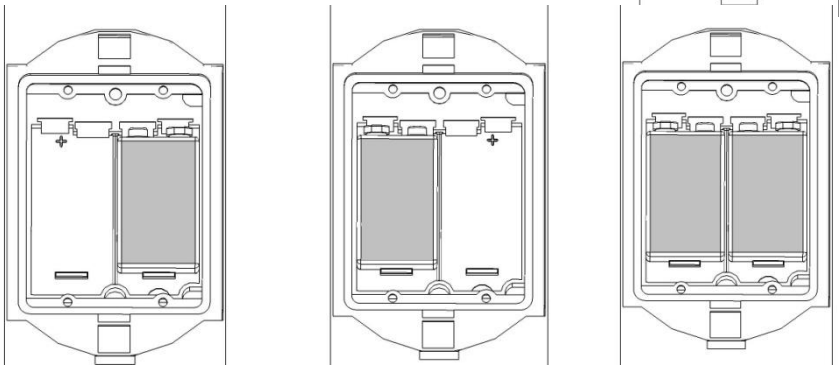

After the batteries are in place, replace the battery compartment lid by sliding the lid back into its place and pressing it down until it “snaps” into place. Immediately after battery insertion, power up the 2x1s tsDCS Stimulator to ensure correct battery placement. If the 2x1s tsDCS Stimulator does not power up, check that the batteries are good and inserted correctly.

Note: Batteries should be removed from the 2x1s tsDCS Stimulator if it is not likely to be used for an extended period of time.



Please observe the proper direction of the battery's polarity as indicated by the stickers inside of the battery compartment. When facing the back of the device, *both* the positive connectors must be toward the outside of the device and *both* the negative connectors toward the inside.

Batteries should be replaced every 2 hours of use or when the low battery indicator is illuminated. Do not use abrasive cleaners on the battery contacts.

To replace the batteries, first remove the old batteries by removing the bottom of the battery first. Take out the batteries one-at-a-time. Then insert the new batteries.



Dispose of depleted batteries in accordance with local regulations.

Note: When the device is not in use, turn the power OFF to save battery life.

Description of Special Features

TRUE CURRENT™: The TRUE CURRENT™ display is active whenever the device is ON. TRUE CURRENT™ always indicates the actual value of current (in mA) being supplied by the device to the electrodes – regardless of device settings. TRUE CURRENT™ thus functions as a fully independent and redundant safety feature when monitored by the operator.

Note: It is recommended the TRUE CURRENT™ be monitored for the entire duration of stimulation.

SMARTscan™: The SMARTscan™ feature provides a constant display of electrode contact quality before, during, and after stimulation. There is no “best” SMARTscan™ level that applies to every tsDCS configuration. With experience, operators can determine ideal, tolerable, and cautionary levels.



SMARTscan™ is a feature intended to assist in the set-up and operation of tsDCS. It is not intended to substitute or replace operator judgment and protocol. Each set-up and operation should be independently monitored and verified by a trained operator following best tsDCS protocols. Any issues or concerns identified by the operator should be addressed regardless of the SMARTscan™ reading.

Stimulation ABORT: At any point during stimulation, the operator may terminate the stimulation by pressing the ABORT button. The operator is responsible for determining when aborting the stimulation is appropriate.

Note: Pressing ABORT will ramp down the current to zero and terminate the entire stimulation run.

RELAX™: At any point during stimulation, the operator may use the RELAX™ slider to decrease the set level of current from the maximum (FULL CURRENT) value. TRUE CURRENT™ will indicate the reduced current value. Adjusting the RELAX™ amount will have no effect on the duration of stimulation. The operator is responsible for determining when to use the RELAX™ feature, for example, based on a subject's discomfort level. It is

important that the RELAX™ amount is decreased and increased slowly, to avoid any sudden current changes.

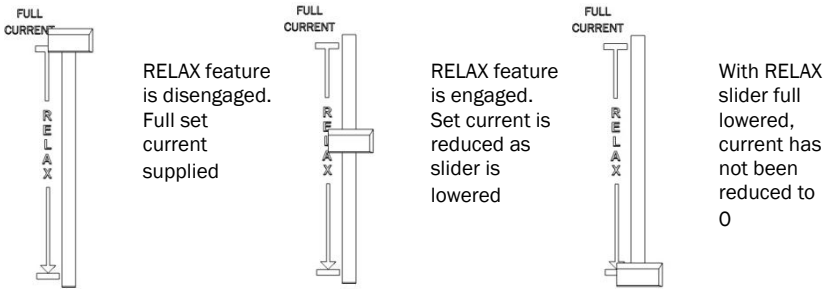

Rapid changes in current level, either decreasing or increasing, should be minimized. When using the RELAX™ feature, always monitor the TRUE CURRENT™ display and adjust slider gradually.

PRE-STIM TICKLE™: When the device is turned ON and after the electrodes are placed on the subject, but before stimulation is initiated, the PRE-STIM TICKLE™ button may be pressed to activate an approximately 30 second, 1 mA current. During PRE-STIM TICKLE™, the TIME REMAINING display will indicate “PR” and the TRUE CURRENT™ display will indicate the current. The operator is responsible for determining when it is appropriate to use PRE-STIM TICKLE™, for example, to condition the electrodes, skin, or the subject. Pressing the PRE-STIM TICKLE™ button during stimulation will have no effect.

Pre-Stimulation Setup

- 1) Turn the POWER switch **ON**. The TRUE CURRENT™ display will illuminate and indicate “0.00.” The SMARTscan™ display will illuminate indicating a low quality.



When the subject is connected to the device, turning the power on or off is not recommended.

- 2) If LOW BATTERY is illuminated, do not proceed with stimulation. Power down the device and replace both batteries with new batteries. Make sure both batteries are inserted in the correct polarity, as indicated inside the battery compartment.
- 3) Clean the surface of the skin to remove any signs of lotion, dirt, etc. and allow it to dry. Inspect the rubber insets and sponges for wear. If there is any evidence of deterioration, throw out the dirty components and use a new electrode.
- 4) Insert the connector cord pin securely into the opening of the receptacle on the rubber inset. (above right)
- 5) Each side of the sponge should be evenly saturated with **Soterix Medical 718** electrolyte or saline solution (total of 10-20 mL per sponge) across the entire surface. **Be careful not to over soak the sponge.** Avoid fluid leaking across the subject.
- 6) Then slide the rubber inset fully into the sponge pad. (5x7 cm sponge shown below)

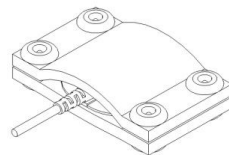
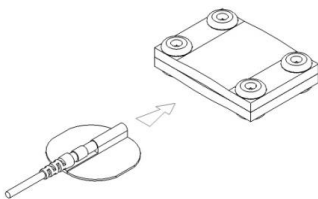
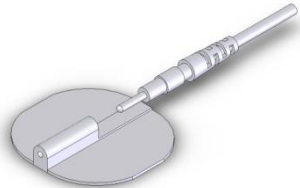

- 7) **Use only appropriate accessories to fix the sponge to the subject** including **Soterix Medical tsDCS Lumbar BODYstrap™**. Apply the electrodes to the treatment site by firmly pressing down the center of the pad and then smoothing down towards the electrode edges. **Verify there is a smooth and even contact with the skin.**

Note: Both sponges must remain evenly moist across the entire surface for the duration of the procedure.



Electrode sponges should remain moist across the entire surface for the duration of stimulation. If the sponges are dry, do not start stimulation. If any irritation or discomfort occurs, discontinue use and consult a clinician

- 8) Connect the provided cables to the device using the banana plugs on the back of the device. To attach the cables, take the long plastic end and insert it into the similarly colored receiver. The red wires must be inserted into the red receivers labeled “anode” and the black wires inserted into the grey receivers labeled “cathode” (below). Refer to steps 8A through 8L for specific instructions for different electrode combinations. Diagrams to aid you in set-up appear on pages 24 and 25.

These steps (8A through 8F) are only for users whose stimulation requires one anode and two cathodes. If your stimulation requires one cathode and two anodes, skip these steps and proceed to steps 8G through 8L.

8A) Connect one anode (red) and one cathode (black) into their proper terminals.

8B) The SMARTscan™ contact quality meter will now indicate the quality of the electrode contact (See figure at top of following page). There is no single “best” reading for all applications; however, generally a higher quality reading indicates a “better” electrode-skin contact. It is the responsibility of the operator to ensure the SMARTscan™ quality reading

is appropriate for a given application prior to stimulation. If the quality reading is not in the desired range, adjust one or both of the electrode contacts. The SMARTscan™ will constantly update showing the current electrode quality during adjustments.

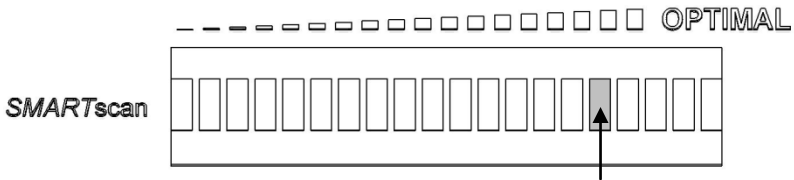

- 8C) Attach the second anode to its proper terminal and ensure the SMARTscan™ Contact Quality reading is in the desired range appropriate for the given application.
- 8D) Disconnect the first anode leaving the original cathode and the second anode and ensure the SMARTscan™ Contact Quality reading is in the desired range appropriate for the given application.
- 8E) Connect the first anode and again ensure the SMARTscan™ Contact Quality reading is in the desired range appropriate for the given application.
- 8F) Skip to step 9 and proceed with pre-stimulation set-up
- These steps (8G through 8L) are only for users whose stimulation requires one cathode and two anodes. If your stimulation requires one anode and two cathodes, refer back to steps 8A through 8F or proceed to step 9.***
- 8G) Connect one anode (red) and one cathode (black) into their proper terminals.
- 8H) The SMARTscan™ contact quality meter will now indicate the quality of

the electrode contact (See figure at top of page). There is no single “best” reading for all applications; however; generally a higher quality reading indicates a “better” electrode-skin contact. It is the responsibility of the operator to ensure the *SMARTscan™* quality reading is appropriate for a given application prior to stimulation. If the quality reading is not in the desired range, adjust one or both of the electrode contacts. The *SMARTscan™* will constantly update showing the current electrode quality during adjustments.

- 8I) Attach the second cathode to its proper terminal and ensure the *SMARTscan™* Contact Quality reading is in the desired range appropriate for the given application.
- 8J) Disconnect the first cathode leaving the original cathode and the anode attached second in their respective sockets and ensure the *SMARTscan™* Contact Quality reading is in the desired range appropriate for the given application.
- 8K) Connect the first cathode and again ensure the *SMARTscan™* Contact Quality reading is in the desired range appropriate for the given application.
- 8L) Proceed to step 9 and continue with pre-stimulation set-up.
- 9) Once the *SMARTscan™* reading is in the desired range, set the CURRENT INTENSITY to the desired current value (in mA) and set DURATION to the desired duration value (in minutes). It is the responsibility of the operator to ensure that the

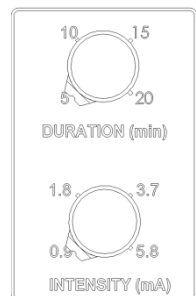

current and duration values are appropriate and safe for the application (right).

Note: The duration value does not include an approximately 30 second ramp up time at the start of stimulation and an approximately 30 second ramp down time at the end of stimulation (normal waveform shown on next page).



10) Select either SHAM ON or OFF using the switch (right).
(SHAM ON waveform show on next page)

11) Ensure the RELAX™ slider is set to FULL CURRENT (right).



12) Now would be the time to activate the PRE-STIM TICKLE™ if desired. To do so, press the PRE-STIM TICKLE™ button (below). It is the responsibility of the operator to determine if it is appropriate to use the PRE-STIM TICKLE™.



Diagrams

Normal Waveform:

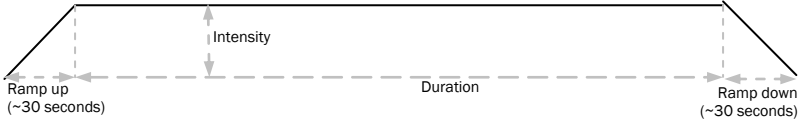

Sham Waveform:

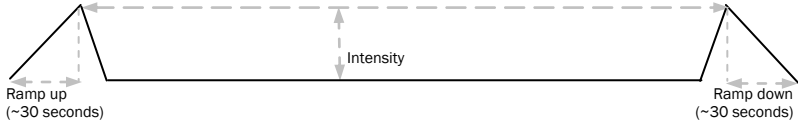

One Anode Two Cathode Diagrams:

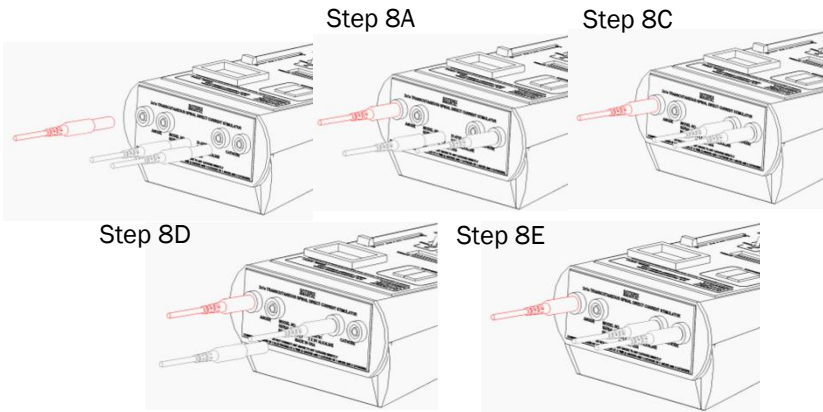

One Cathode Two Anode Diagrams:

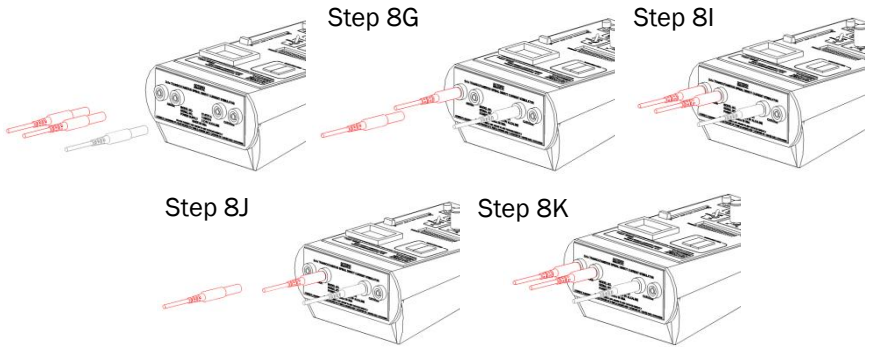

Stimulation Procedure

- 1) Confirm that both the intensity and duration are set to the desired values, SHAM is set to its desired setting, and the RELAX™ slider is set to FULL CURRENT.
- 2) Start the stimulation by pressing the START button (right)



Note: Once the START button is pressed and tsDCS begins, changing the duration and intensity knobs will have no effect on the ongoing stimulation. These knobs are to be set before the start of the stimulation to allow for proper tsDCS.

- 3) The stimulation ACTIVE light will first flash for a period of approximately 30 seconds while the current is ramping up. The TRUE CURRENT™ display will show the current ramping up to the set INTENSITY value.
- 4) Once the ramp up is complete, the stimulation ACTIVE light will stop flashing and remain illuminated. The TIME REMAINING display will now indicate the time remaining in the stimulation session. The value will start at the time selected in DURATION and count down. The value will initially show the amount of minutes remaining.
- 5) The TRUE CURRENT™ display constantly shows the current delivered to the subject. The operator should monitor this display. If there is any deviation from the expected current, as set by the operator and described in this manual, stimulation should be aborted.
- 6) The SMARTscan™ feature indicates contact quality during stimulation. The operator should monitor this display during stimulation. It is typical for electrode quality to decrease during stimulation, while an increase may indicate a problem with the electrodes. The stimulator will *not* automatically shut down during stimulation. It is the responsibility of the operator to ensure that the SMARTscan™ quality reading is appropriate for a given application during stimulation.



During tsDCS, tampering with the placement of the sponges is not recommended.

7) The RELAX™ feature can be used at any point during the stimulation, generally, the RELAX™ feature is used to accommodate individual subjects by moving the RELAX™ slider down, away from FULL CURRENT, the current supplied by the device will decrease to the value shown in the TRUE CURRENT™ DISPLAY.

8) When there is 1 minute remaining in the stimulation, the TIME REMAINING display will switch to seconds. It will count down the final 60 seconds. This will be indicated by the illumination of the light adjacent to “Sec” below the TIME REMAINING display.

9) When the TIME REMAINING reaches zero, the display will turn OFF and the current will ramp down for approximately 30 seconds. During the ramp down, the stimulation ACTIVE light will flash.

10) Once the ramp down is complete, the stimulation ACTIVE light will turn OFF.

11) tsDCS is now complete.

12) Disconnect the electrodes from the subject.

13) Turn the POWER switch OFF.

Note: If during the course of stimulation, it is desired to stop the stimulation manually, it is recommended that the ABORT feature be used instead of the power being switched off.



When the subject is connected to the device, turning the power ON or OFF is not recommended.

Specifications and Warranty

Specifications -- 30

Warranty -- 31

This chapter is comprised of the following sections:

Specifications:

Here you can find a list of the details of the device specification.

Warranty:

Here is the Limited Warranty. It dictates under what circumstances your 2x1s Transcutaneous Spinal Direct Current Stimulator is repaired free of charge. It also explains how to obtain your warranty service.

Specifications

Electrical and Operating Characteristics

Power source: 2 9V Alkaline batteries
 Battery life (with fresh batteries): 3 hrs
 Length: 7.91 in.
 Width: 5.9 in.
 Height: 2.83 in.
 Connector type: shielded banana

Storage and Operating Conditions

Parameter	Storage	Operating
<i>Minimum temperature</i>	50 °F	55 °F
<i>Maximum temperature</i>	80 °F	85 °F
<i>Maximum humidity</i>	70% non-condensing	70% non-condensing
<i>Minimum atmospheric pressure</i>	20.7 in. Hg (700 hPa)	20.7 in. Hg (700 hPa)
<i>Maximum atmospheric pressure</i>	31.3 in. Hg (1060 hPa)	31.3 in. Hg (1060 hPa)

*All measurements are approximate

Warranty

Soterix Medical Limited Warranty

- A.** This Limited Warranty provides the following assurance to the first purchaser of the **Soterix Medical Inc.** 2x1s tsDCS Stimulator Model 0707-A, hereafter referred to as "Equipment":
- (2) Should the Equipment fail to function within normal tolerances due to a defect in materials or workmanship within a period of one (1) year, commencing with the delivery of the Equipment to the purchaser, **Soterix Medical** will at its option: (a) repair or replace any part or parts of the Equipment; (b) issue a credit to the purchaser equal to the Purchase Price against the purchase of the replacement Equipment or (c) provide a functionally comparable replacement Equipment at no charge. The Equipment must be returned to **Soterix Medical Inc.**, carriage paid and insured, in the most appropriate method as determined by **Soterix Medical Inc.**
 - (3) As used herein, Purchase Price shall mean the lesser of the net invoiced price of the original, or current functionally comparable, or replacement Equipment.
- B.** To qualify for Limited Warranty set forth in Section A(1), the following conditions must be met:
- (2) The Equipment must be returned to **Soterix Medical** within thirty (30) days after discovery of the defect. (**Soterix Medical** may, at its option, repair the Equipment on site).
 - (3) The Equipment must not have been repaired or altered outside of **Soterix Medical's** factory in any way, which, in the judgment of **Soterix Medical**, affects its stability and reliability. The Equipment must not have been subjected to misuse, abuse, or accident. This warranty does not apply to any exterior appearance item of the Equipment which has been damaged or defaced, which has been subject to misuse and abuse, abnormal service or handling, or which has been altered or modified in design or construction.
 - (4) This warranty does not apply to any interconnection cables supplied with the Equipment.
- C.** This Limited Warranty is limited to its expressed terms. In particular:
- (1) Except as expressly provided by this Limited Warranty, **SOTERIX MEDICAL IS NOT RESPONSIBLE FOR ANY DIRECT, INCIDENTAL, OR CONSEQUENTIAL DAMAGES BASED ON ANY DEFECT FAILURE OR MALFUNCTION OF THE EQUIPMENT, WHETHER THE CLAIM IS BASED ON WARRANTY, CONTRACT, TORT, OR OTHERWISE.**

- (2) This Limited Warranty is made only to the purchaser of the Equipment. AS TO ALL OTHERS, **SOTERIX MEDICAL INC.** MAKES NO WARRANTY, EXPRESS OR IMPLIED, INCLUDING, BUT NOT LIMITED TO, ANY IMPLIED WARRANTY OF MERCHANTABILITY OR FITNESS FOR A PARTICULAR PURPOSE WHETHER ARISING FROM STATUTE, COMMON LAW, CUSTOM, OR OTHERWISE. NO EXPRESS OR IMPLIED WARRANTY TO THE PATIENT SHALL EXTEND BEYOND THE PERIOD SPECIFIED IN A(1) ABOVE, THIS LIMITED WARRANTY SHALL BE THE EXCLUSIVE REMEDY AVAILABLE TO ANY PERSON.
- (3) The exclusions and limitations set out above are not intended to, and should not be construed so as to contravene mandatory provisions of applicable law. If any part or term of this Limited Warranty is held to be illegal, unenforceable, or in conflict with applicable law by a court of competent jurisdiction, the validity of the remaining portions of the Limited Warranty shall not be affected, and all rights and obligations shall be construed and enforced as if this Limited Warranty did not contain the particular part or term held to be invalid. This Limited Warranty gives the purchaser specific legal rights. The purchaser may also have other rights, which vary within specific regions.
- (4) No person has any authority to bind **Soterix Medical Inc.** to any representation, condition, or warranty except this Limited Warranty.

Obtaining Warranty Service

Warranty service of this Equipment can be obtained by returning the Equipment, carriage paid and insured, to **Soterix Medical**. Prior authorization before shipping the product is advised for the most expedient service.

Further Information

In this chapter, you can find:

Bibliography:

Here is a selection of peer-reviewed articles that **Soterix Medical** has found to be relevant to tsDCS practices.

Contact Information:

This section houses a list of all the ways **Soterix Medical** can be contacted.

Bibliography

The following bibliography includes a selection of peer-reviewed publications. This is not a comprehensive list of all tsDCS studies, but includes a representative list as of the date of the publication of this manual. The inclusion of these reports in this bibliography does not in any way imply an endorsement of the protocol or results reported in these studies by **Soterix Medical**. It remains the responsibility of the device user to remain informed of all current, relevant tsDCS practices. tsDCS is an investigational medical technique and has not been cleared by the FDA; it can therefore only be used for research under appropriate Institutional Review Board guidelines.

- 1) Truini A, Vergari M, Biasiotta A, La Cesa S, Gabrielle M, Di Stefano G, Cambrieri C, Cruccu G, Inghilleri M, Priori A. Transcutaneous Spinal Direct Current Stimulation inhibits nociceptive spinal pathway conduction and increases pain tolerance in humans. *Eur J Pain*. 2011.
- 2) Zaghoul A. Trans-spinal direct current stimulation modulates motor cortex-induced muscle contraction in mice. *J Appl Physiol*. 2011; 110(5): 1414-24.
- 3) Winkler T, Hering P, Straube A. Spinal DC stimulation in humans modulates post-activation depression of the H-reflex depending on current polarity.
- 4) Cogiamanian F, Vergari M, Pulecchi F, Marceglia S, Priori A. Effect of spinal Transcutaneous direct current stimulation on somatosensory evoked potential in humans. *Clin Neurophysiol*. 2008; 119(11): 2636-40.

Contact Information

Soterix Medical, Inc.
160 Convent Avenue, ST-142
New York, NY 10031
www.SoterixMedical.com
contact@soterixmedical.com

Thank you for purchasing a **Soterix Medical 2x1s Transcutaneous Spinal Direct Current Stimulator**.



If you arrive at a problem, or have any questions, comments, or concerns, please feel free to contact us at SoterixMedical.com

